

Technical data sheet

Optical distance sensor

Part no.: 50137818
ODS9L2.8/LAK-450-M12

Contents

- Technical data
- Dimensioned drawings
- Electrical connection
- Diagrams
- Operation and display
- Part number code
- Notes
- Accessories



For illustration purposes only



CDRH



Technical data

Basic data

| | |
|-------------------------|---|
| Series | 9 |
| Application | Fill-level monitoring Length measurement in material cutting Object measurement |
| Type of scanning system | Against object |

Special version

| | |
|-----------------|---|
| Special version | Activation input Deactivation input Teach input |
|-----------------|---|

Optical data

| | |
|--------------------------------------|------------------------|
| Beam path | Collimated |
| Light source | Laser, Red |
| Wavelength | 650 nm |
| Laser class | 2, IEC/EN 60825-1:2014 |
| Transmitted-signal shape | Pulsed |
| Pulse duration | 22.000 µs |
| Light spot size [at sensor distance] | 1 mm [450 mm] |
| Type of light spot geometry | Round |

Measurement data

| | |
|--|----------------------|
| Measurement range | 50 ... 450 mm |
| Resolution | 0.1 mm |
| Accuracy | 1 % |
| Reference value, accuracy | Measurement distance |
| Reproducibility (1 sigma) | 0.1 mm |
| Temperature drift | 0.02 %/K |
| Referencing | No |
| Optical distance measurement principle | Triangulation |

Electrical data

| | |
|--------------------|---|
| Protective circuit | Polarity reversal protection Short circuit protected Transient protection |
|--------------------|---|

Performance data

| | |
|----------------------|------------------------|
| Supply voltage U_B | 18 ... 30 V, DC |
| Residual ripple | 0 ... 15 %, From U_B |
| Open-circuit current | 0 ... 50 mA |

Inputs

| | |
|------------------------------------|------------|
| Number of digital switching inputs | 1 Piece(s) |
|------------------------------------|------------|

Switching inputs

| | |
|-------------------|-------|
| Voltage type | DC |
| Switching voltage | U_B |

Digital switching input 1

| | |
|----------|--|
| Function | Activation input Deactivation input Teach input Trigger |
|----------|--|

Outputs

| | |
|-------------------------------------|------------|
| Number of analog outputs | 1 Piece(s) |
| Number of digital switching outputs | 1 Piece(s) |

Analog output 1

| | |
|------------|--|
| Type | Configurable, factory setting: current |
| Assignment | Connection 1, pin 2 |

Switching outputs

| | |
|-------------------|---|
| Voltage type | DC |
| Switching voltage | high: $\geq(U_B-2V)$ low: $\leq 2 V$ |

Switching output 1

| | |
|---------------------|--|
| Assignment | Connection 1, pin 4 |
| Switching element | Transistor, Push-pull |
| Switching principle | IO-Link / light switching (PNP)/dark switching (NPN) |

Time behavior

| | |
|-----------------|--|
| Response time | 1 ms, Under constant ambient conditions, 90% diffuse reflection, standard measure mode |
| Readiness delay | 300 ms |

Interface

| | |
|------|---------|
| Type | IO-Link |
|------|---------|

IO-Link

| | |
|------------------|----------------------|
| COM mode | COM3 |
| Profile | Smart sensor profile |
| Min. cycle time | COM3 = 0.5 ms |
| Frame type | 2.V |
| Port type | A |
| Specification | V1.1 |
| SIO-mode support | Yes |
| Process data IN | 4 byte |
| Process data OUT | 8 bit |
| Dual Channel | Yes |

Connection

| | |
|-----------------------|------------|
| Number of connections | 1 Piece(s) |
|-----------------------|------------|

Connection 1

| | |
|--------------------|---|
| Function | Signal IN Signal OUT Voltage supply |
| Type of connection | Connector, Turning, 90° |
| Thread size | M12 |
| Type | Male |
| Material | Plastic |
| No. of pins | 5 -pin |
| Encoding | A-coded |

Mechanical data

| | |
|-----------------------|---|
| Design | Cubic |
| Dimension (W x H x L) | 21 mm x 50 mm x 50 mm |
| Housing material | Plastic |
| Lens cover material | Glass |
| Net weight | 50 g |
| Housing color | Red |
| Type of fastening | Through-hole mounting Via optional mounting device |

Technical data

Operation and display

| | |
|----------------------|-----------------|
| Type of display | LED |
| | OLED display |
| Number of LEDs | 2 Piece(s) |
| Operational controls | Control buttons |
| | PC software |

Environmental data

| | |
|--------------------------------|-------------------------|
| Ambient temperature, operation | -20 ... 50 °C |
| Ambient temperature, storage | -30 ... 70 °C |
| Ambient light sensitivity | 20,000 lx, EN 60947-5-2 |

Certifications

| | |
|----------------------|-------|
| Degree of protection | IP 67 |
| Protection class | III |
| Certifications | UL |

Classification

| | |
|-----------------------|----------|
| Customs tariff number | 90318020 |
| ECLASS 5.1.4 | 27270801 |
| ECLASS 8.0 | 27270801 |
| ECLASS 9.0 | 27270801 |
| ECLASS 10.0 | 27270801 |
| ECLASS 11.0 | 27270801 |
| ECLASS 12.0 | 27270916 |
| ECLASS 13.0 | 27270916 |
| ECLASS 14.0 | 27270916 |
| ETIM 5.0 | EC001825 |
| ETIM 6.0 | EC001825 |
| ETIM 7.0 | EC001825 |
| ETIM 8.0 | EC001825 |
| ETIM 9.0 | EC001825 |

Dimensioned drawings

All dimensions in millimeters

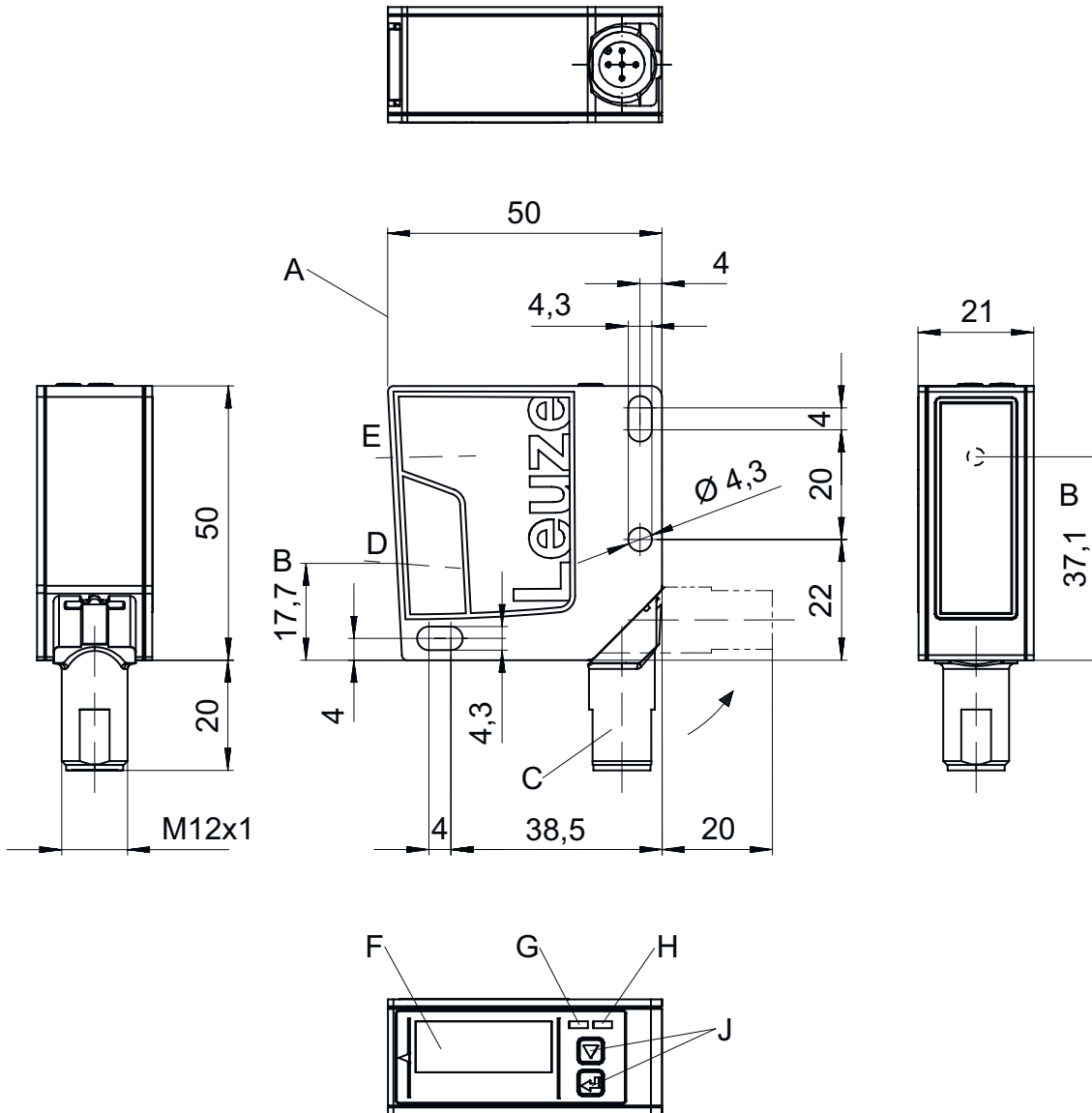

- | | | | | | |
|---|------------------------------------|---|---------------|---|-----------------|
| A | Reference edge for the measurement | E | Transmitter | J | Control buttons |
| B | Optical axis | F | Color display | | |
| C | Device plug M12 | G | Yellow LED | | |
| D | Receiver | H | Green LED | | |

Electrical connection

Connection 1

| | |
|--------------------|----------------|
| Function | Signal IN |
| | Signal OUT |
| | Voltage supply |
| Type of connection | Connector |
| Thread size | M12 |
| Type | Male |
| Material | Plastic |
| No. of pins | 5 -pin |
| Encoding | A-coded |

| Pin | Pin assignment |
|-----|------------------|
| 1 | 18 ... 30 V DC + |
| 2 | OUT mA / V |
| 3 | GND |
| 4 | IO-Link / OUT 1 |
| 5 | multi funct |

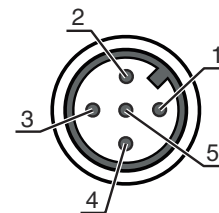

Diagrams

Characteristic curve of analog output

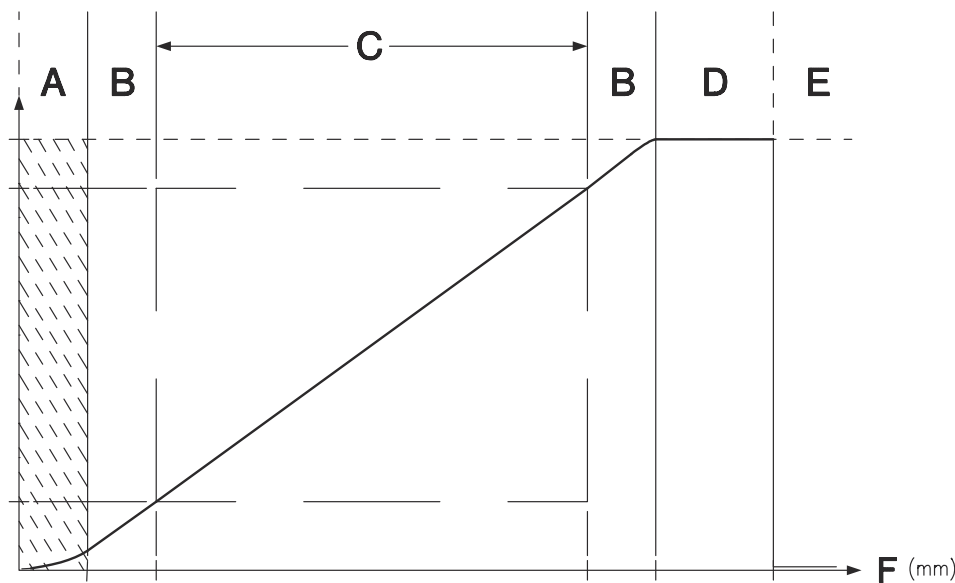

- A Area not defined
- B Linearity not defined
- C Measurement range
- D Object detected
- E No object detected (characteristic curve behavior adjustable via IO-Link)
- F Measurement distance

Diagrams

Accuracy of measurement

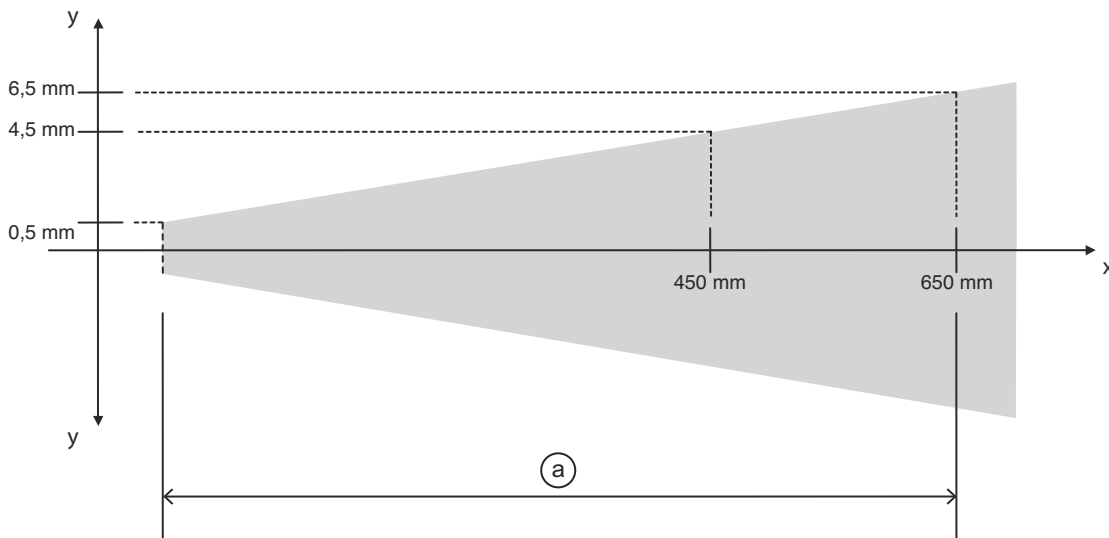

- x Measurement distance
- y Max. measurement error
- a 1% of measurement value

Operation and display

| LED | Display | Meaning |
|-----|--------------------------|---------------------------------|
| 1 | Green, continuous light | Ready |
| 2 | Yellow, continuous light | Object in the measurement range |

Part number code



Part designation: ODS9XX.Y/ZAB-CCC-DDD



| | |
|-------------|---|
| ODS9 | Operating principle Optical distance sensor of the 9 series |
| XX | Light source L2: laser class 2 L1: laser class 1 |
| Y | Equipment 8: OLED display and membrane keyboard for configuration |
| Z | Switching output/function OUT 1/IN: Pin 4 or black conductor L: IO-Link |
| A | Switching output / function OUT 2/IN: pin 2 or white conductor A: Analog output 6: push-pull switching output, PNP light switching, NPN dark switching |
| B | Switching output / function OUT 3/IN: Pin 5 X: pin not used 6: push-pull switching output, PNP light switching, NPN dark switching K: Multifunction input (factory setting: deactivation input) |

Part number code

| | |
|--|--|
| CCC | Operating range 100: operating range 50 ... 100 mm 200: operating range 50 ... 200 mm 450: operating range 50 ... 450 mm 650: operating range 50 ... 650 mm 1050: operating range 50 ... 1050 mm |
| DDD | Electrical connection M12: M12 connector |
| Note | |
|  | <ul style="list-style-type: none"> ↪ A list with all available device types can be found on the Leuze website at www.leuze.com. |

Notes

| | |
|--|---|
|  Observe intended use! | |
|  | <ul style="list-style-type: none"> ↪ This product is not a safety sensor and is not intended as personnel protection. ↪ The product may only be put into operation by competent persons. ↪ Only use the product in accordance with its intended use. |

| | |
|---|---|
|  ATTENTION! LASER RADIATION – CLASS 2 LASER PRODUCT | |
|  | <p>Do not stare into beam! The device satisfies the requirements of IEC 60825-1:2007 (EN 60825-1:2007) safety regulations for a product of laser class 2 as well as the U.S. 21 CFR 1040.10 regulations with deviations corresponding to Laser Notice No. 50 from June 24, 2007.</p> <ul style="list-style-type: none"> ↪ Never look directly into the laser beam or in the direction of reflected laser beams! If you look into the beam path over a longer time period, there is a risk of injury to the retina. ↪ Do not point the laser beam of the device at persons! ↪ Interrupt the laser beam using a non-transparent, non-reflective object if the laser beam is accidentally directed towards a person. ↪ When mounting and aligning the device, avoid reflections of the laser beam off reflective surfaces! ↪ CAUTION! Use of controls or adjustments or performance of procedures other than specified herein may result in hazardous light exposure. ↪ Observe the applicable statutory and local laser protection regulations. ↪ The device must not be tampered with and must not be changed in any way. There are no user-serviceable parts inside the device. Repairs must only be performed by Leuze electronic GmbH + Co. KG. |





| | |
|--|---|
| NOTE | |
|  | <p>Affix laser information and warning signs! Laser information and warning signs are affixed to the device. In addition, self-adhesive laser information and warning signs (stick-on labels) are supplied in several languages.</p> <ul style="list-style-type: none"> ↪ Affix the laser information sheet to the device in the language appropriate for the place of use. When using the device in the US, use the stick-on label with the "Complies with 21 CFR 1040.10" note. ↪ Affix the laser information and warning signs near the device if no signs are attached to the device (e.g. because the device is too small) or if the attached laser information and warning signs are concealed due to the installation position. ↪ Affix the laser information and warning signs so that they are legible without exposing the reader to the laser radiation of the device or other optical radiation. |

Accessories

Connection technology - Connection unit

| | Part no. | Designation | Article | Description |
|--|----------|-----------------------|----------------|---|
|  | 50144900 | MD 798i-11-82/L5-2222 | IO-Link master | Type: IO-Link master Current consumption, max.: 11,000 mA Switching outputs for each sensor connection: 1 Piece(s) Switching output: Transistor, PNP Interface: IO-Link, Automatic protocol detection, EtherNet IP, Modbus TCP, PROFINET Connections: 12 Piece(s) Sensor connections: 8 Piece(s) Connections for voltage supply: 2 Piece(s) Interface connections: 2 Piece(s) Degree of protection: IP 67, IP 65, IP 69K |

Connection technology - Connection cables



| | Part no. | Designation | Article | Description |
|--|----------|--------------------|------------------|--|
|  | 50133855 | KD S-M12-5A-V1-020 | Connection cable | Connection 1: Connector, M12, Axial, Female, A-coded, 5 -pin Connector, LED: No Connection 2: Open end Shielded: Yes Cable length: 2.000 mm Sheathing material: PVC |
|  | 50133856 | KD S-M12-5A-V1-050 | Connection cable | Connection 1: Connector, M12, Axial, Female, A-coded, 5 -pin Connector, LED: No Connection 2: Open end Shielded: Yes Cable length: 5.000 mm Sheathing material: PVC |
|  | 50132077 | KD U-M12-5A-V1-020 | Connection cable | Connection 1: Connector, M12, Axial, Female, A-coded, 5 -pin Connector, LED: No Connection 2: Open end Shielded: No Cable length: 2.000 mm Sheathing material: PVC |
|  | 50132079 | KD U-M12-5A-V1-050 | Connection cable | Connection 1: Connector, M12, Axial, Female, A-coded, 5 -pin Connector, LED: No Connection 2: Open end Shielded: No Cable length: 5.000 mm Sheathing material: PVC |

Mounting technology - Mounting brackets

| | Part no. | Designation | Article | Description |
|---|----------|-------------|------------------|---|
|  | 50118543 | BT 300M.5 | Mounting bracket | Design of mounting device: Angle, L-shape Fastening, at system: Through-hole mounting Mounting bracket, at device: Screw type, Suited for M4 screws Type of mounting device: Adjustable Material: Stainless steel |

Accessories

Mounting technology - Rod mounts

| | Part no. | Designation | Article | Description |
|---|----------|--------------|-----------------|--|
|  | 50117252 | BTU 300M-D12 | Mounting system | Design of mounting device: Mounting system Fastening, at system: For 12 mm rod, Sheet-metal mounting Mounting bracket, at device: Screw type, Suited for M4 screws Type of mounting device: Clampable, Adjustable, Turning, 360° Material: Metal |
|  | 50128380 | BTU 460M-D12 | Mounting system | Design of mounting device: Mounting system Fastening, at system: For 12 mm rod Mounting bracket, at device: Screw type Type of mounting device: Adjustable, Turning, 360° Material: Metal |

Configuration devices

| | Part no. | Designation | Article | Description |
|---|----------|------------------------------|-----------------|--|
|  | 50121098 | SET MD12-US2-IL1.1 + Zub. | Diagnostics set | Interface: USB Connections: 2 Piece(s) Degree of protection: IP 20 |

Note



A list with all available accessories can be found on the Leuze website in the Download tab of the article detailed page.